

AM8a PCM/VF Call Analyzer Test Procedure Guide

Addendum to
AM8a Instruction Manual



AM8A PCM/VF CALL ANALYZER Test Procedure Guide

Addendum to Am8a Instruction Manual

June 1996

**Technical Data Subject to
Change without Notice**



760 Arrow Grand Circle
Covina, CA 91722 USA
TEL 626.915.5441
FAX 626.915.7181
www.ameritec.com

**For extra copies of
this manual order
P/N 18-0133**

© 2000 Ameritec Corporation

AM8a PCM/VF Call Analyzer Test Procedure Guide

Addendum to AM8a Instruction Manual

June 1996

INTRODUCTION

This Test Procedure Guide provides summarized information about the setup and operation of the AM8a PCM/VF Call Analyzer. It consists of General Information on the operation of the unit and Application Notes.

This Test Procedure Guide can be ordered separately as Part Number 18-0133. It is also included at the end of AM8a PCM/VF Call Analyzer Instruction Manuals (18-0037). A quick reference card is also available separately by contacting Ameritec Sales Department.

TABLE OF CONTENTS

GENERAL INFORMATION.....	1
THE FRONT PANEL.....	1
START-UP AND DEFAULT SETTINGS.....	2
SHIFT KEY.....	2
THE SETUP SECTION	2
SETUP: CONFIGURATION	2
SETUP: EMULATE	3
SETUP: ANALYZE.....	3
SETUP: AUTODIAL.....	3
THE DISPLAY SECTION.....	3

THE ON/OFF SECTION	3
INPUT.....	3
TIMS.....	3
TALK.....	3
AUTO.....	3
FUNCTION KEYS AND STATUS LEDs	4
SEIZE.....	4
START.....	4
RING.....	4
REV (Reverse).....	4
STORE/RECALL OF AM8a PARAMETERS	4
APPLICATION NOTE #1: CUSTOM CALLING FEATURES USING THE AUDODIAL FIELD	5
APPLICATION NOTE #2: DS1/T1 DROP AND INSERT	8
SETUP PROCEDURES.....	8
CONFIGURE DIALED DIGITS AND DIAL TYPE.....	10
DROP AND INSERT TEST.....	11
APPLICATION NOTE #3: DIRECT INWARD DIAL (DID)/911	12
SETUP PROCEDURES.....	12
OPERATION.....	13
APPLICATION NOTE #4: SLC®96 MONITORING AND DATA LINK ANALYSIS	14
SETUP PROCEDURES.....	14
VIEW SPAN RESULTS AND ALARM CONDITIONS.....	15
VIEW SIGNALING EVENTS (DIGITS, TONES, SEIZURES).....	16
MODE II OPERATION.....	16
DATALINK MONITORING.....	16

APPLICATION NOTE #5: DS1/T1 SIGNAL MONITORING	18
SETUP PROCEDURES	18
PARAMETER CHANGES.....	19
METER DISPLAY (A/B BIT STATES, SPAN ERRORS, ETC.)	19
A/B SIGNALING	20
APPLICATION NOTE #6: ORIGINATING OR TERMINATING A DS/T1 CALL	21
SETUP PROCEDURES	21
OPERATION.....	22
TERMINATING AN INBOUND CALL	23
ORIGINATING A CALL	23
APPLICATION NOTE #7: DIGIT ANALYSIS AND EXCEPTION REPORTING.....	24
SETUP PROCEDURES	24
CONFIGURING ANALYZE THRESHOLDS	25
OPERATION.....	26
DISPLAYING EXCEPTIONS.....	26

AM8a PCM/VF Call Analyzer

Test Procedure Guide

GENERAL INFORMATION

This section provides general information about the front panel of the Ameritec AM8a Test Set. Topics are limited to the location and function of switches, keys, LEDs, and displays used for controlling the unit and indicating its operational status. Refer to the AM8a Instruction Manual for a complete description of each front panel component if required.

THE FRONT PANEL

The front panel consists of four (4) major areas:

1. The Setup section.
2. The Display section.
3. The On/Off section.
4. The Function keys and Status LEDs.

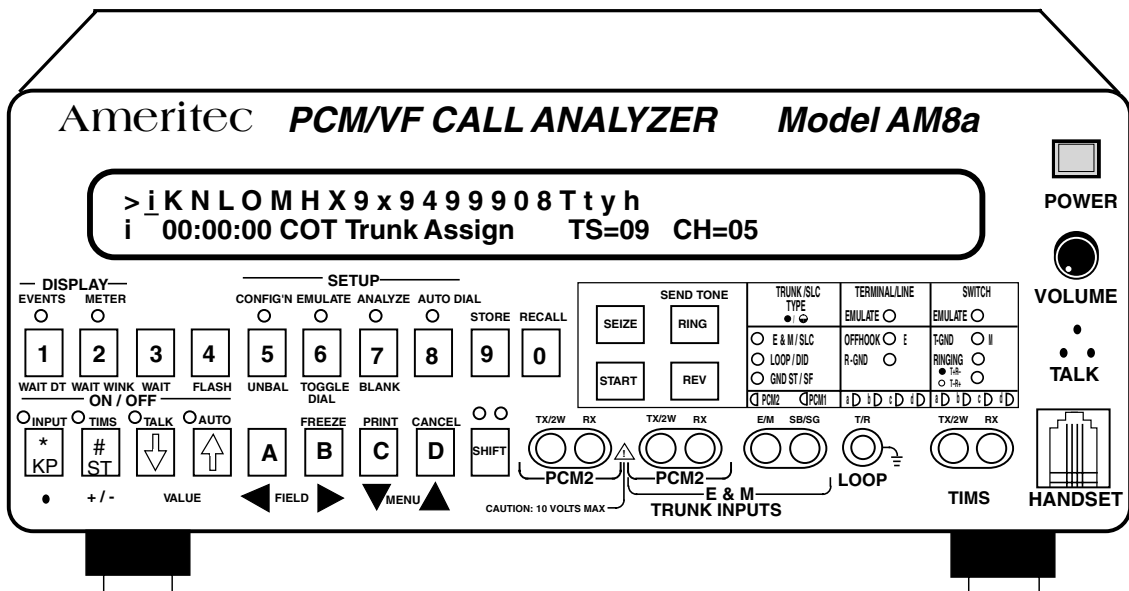

In addition to these four areas, the panel contains the following keys, switches and jacks:

- * The Store and Recall keys used to store and then recall and execute either front panel setups or auto-dial sequences.
- * A volume control knob (to the right of the display) to control the volume of the speaker located in the bottom of the unit.
- * The Power ON/OFF button (above the volume control knob).
- * Bantam jacks (bottom right hand corner) for connecting the test set to the line.
- * A SHIFT key (left of bantam jacks) that controls access to green function keys or red dialing keys. Press SHIFT key once to access green keys and twice to access red keys.

START-UP AND DEFAULT SETTINGS

When the AM8a is initially powered on, it runs through a self-test procedure. All LEDs light for approximately three (3) seconds. After 3 seconds, if no internal problem is diagnosed, the unit assumes its default state, which is to monitor a DS1/T1 circuit (channel 1). If the user desires to monitor a DS1 circuit, he need only to connect the circuit to the test set and set the INPUT selection switch to ON.

SHIFT KEY

The SHIFT key is located to the left of the bantam input jacks of the AM8a. This key allows the AM8a to use one key for several different functions. When the SHIFT key is not illuminated (off), the function of the keys will be written in black/white. With the SHIFT key pressed once, the green LED will illuminate and now any key that has green functions written above it can now be accessed.

For example, to select the EMULATE menu, the user would press [SHIFT], [6]. To access any of the red dial functions, the user should press the SHIFT key twice and then the key directly above the red function. Once a key has been pressed after the SHIFT key is illuminated, the SHIFT LED will turn off and the user will need to repeat the process to access another green or red function.

THE SETUP SECTION

The **SETUP** section is divided into four (4) different areas: **CONFIGURATION**, **EMULATE**, **ANALYZE** and **AUTODIAL**. These areas represent menus that control various setup aspects for configuring the AM8a for a given test. Each area is briefly described below:

SETUP: CONFIGURATION

This menu determines whether the AM8a will be used for analog or T1 circuits and what type of circuit will be monitored or emulated. Additionally, RS232 port selections, types of events that the user wishes to display and which end of the circuit the AM8a is emulating are all selected here.

SETUP: EMULATE

This menu is primarily used to configure the C.O. characteristics of a circuit such as ring voltage, dial tone characteristics and cadences, loop length and start signal. Additionally, if the user desires to offset any dialed numbers, the ability to control digit levels, frequencies and on/off timing can be set here for pulse or tone dialing.

SETUP: ANALYZE

This menu is only used to set up user-defined error thresholds for any signaling event whether it be wink timing, digit analysis, tone analysis, etc. This menu does not affect the AM8a's ability to decode any event — only whether that event is to be considered in violation of preset thresholds.

SETUP: AUTODIAL

This menu allows the user to program up to 10 autodial sequences. These dialed number strings may be up to 60 events each and can contain complex variables such as wait for wink, pause for tone, toggle from MF to DTMF, etc. The autodial sequence selected is enabled by toggling the AUTO LED to the ON position in the bottom left corner of the unit.

THE DISPLAY SECTION

The **DISPLAY** section is divided into **EVENTS** and **METER**. The **EVENTS** display is selected when the user desires to capture digits and signaling events. The **METER** display is used to Display VOM measurements, display **PCM** measurements or look at SLC®96 alarm fields.

THE ON/OFF SECTION

This section allows the user to selectively toggle ON/OFF the following functions:

- * **INPUT** - This switch electronically connects the test set to the line under test.
- * **TIMS** - This switch activates the TIMS jacks on the AM8a.
- * **TALK** - This switch activates the internal microphone.
- * **AUTO** - This switch acts to activate the autodial sequence if emulating a terminal device or provide the proper start signal upon detection of seizure if emulating a switch.

FUNCTION KEYS AND STATUS LEDs

In the center of the AM8a front panel, there reside 4 function keys labeled **SEIZE**, **START**, **RING (SEND TONE)** and **REV**. These keys provide manual control (on/off) of these functions and are described briefly below:

- * **SEIZE** - Controls On Hook and Off Hook state of circuit under test.
- * **START** - This key will provide the start signal as defined in the **SETUP: EMULATE** section.
- * **RING** - This keys initiates the ring generator. The ring generator will continue to produce ringing as defined in **SETUP: EMULATE** section until ring trip is detected.

- * **REV** - (Reverse) This key will provide reverse battery to the circuit under test.

The status LED's located in the front panel blue box give the user an immediate indication of how the unit has been configured for a given test. On hook/Off hook status, ringing, battery reversal, etc. are also displayed to allow the user to pinpoint any potential network problem.

STORE/RECALL OF AM8a PARAMETERS

The **STORE** and **RECALL** keys are located in green over the "9" and "0" keys. To access these functions, the user must remember to first press the **SHIFT** key before pressing the **STORE** or **RECALL** key.

The AM8a provides up to 20 locations for storing **SETUP: CONFIGURATION** parameters. These locations are numbered 00 through 19. Additionally, 20 more locations are provided for storing **SETUP: EMULATE/ANALYZE** parameters and they are numbered 20 through 39.

It is important to remember that because the **SETUP: CONFIGURATION** parameters are stored separately from the **SETUP: EMULATE / ANALYZE** parameters, the user needs to store each set of parameters for a given test. To **STORE** the **SETUP: CONFIGURATION** parameters, the AM8a must first have its **SETUP: CONFIGURATION LED** on. Likewise, to **STORE** any parameters in the **SETUP: EMULATE / ANALYZE** section, one of those two **LEDs** must be on.

APPLICATION NOTE #1

Custom Calling Features Using the Autodial Field

The following example illustrates how the AM8a can be configured to simulate a conference call over the Sprint network by programming a complex dial sequence into the AM8a's autodial field. Through the front panel keypad an operator can dial any sequence of digits and events either manually or automatically and store up to 10 of these sequences in the autodial section for later recall.

This example shows the sequence of events used to test the conference calling feature on a switch utilizing the Sprint network:

1. Power up the AM8a and wait 3 seconds for self test to complete.
2. Press [SHIFT], [8] to enter autodial section.
3. With the blinking cursor to the far left of the display, select the appropriate autodial field (0 - 9) by pressing the MENU up/down keys until the desired field is displayed.
4. With the field selected, enter in the dialed number, in this case:

***nnzzzzzzzzzz#*8008778000#TT08189155441-bbbbbbbbbbbbbbb-kkk**
where,

***nnzzzzzzzzzz#** is a MF digit string, whereby nn = facilities code and identifies that the call is coming from a pay phone, hotel, prison, etc. and **zzzzzzzzzz** = the ANI string that identifies the switch the call is originating from,

***8008778000#** is a MF digit string that routes the call to a Sprint switch in Kansas City,

TT is the AM8a command to toggle back to DTMF dialing.

08189155441 is the desired party's number that has been dialed in DTMF

- is the AM8a command that provides a 3 second wait before dialing next digit

bbbbbbbbbbbbbb is the phonecard PIN number

- is the AM8a command that provides a 3 second wait before dialing next digit.

kkk is a 3 digit DTMF Authorization Code that is used when a number of users share the same PIN number.

Note that the events **TT** and **-** require the user to first press the **[SHIFT]** key twice in order to be entered into the sequence of events.

5. Press **[SHIFT]**, **[5]** to setup the AM8a for terminal dialing.
6. Press the **MENU** keys until the display shows:

IMITATE	MODE
switch	monitor
7. Press the **FIELD** and **VALUE** keys until the display shows:

IMITATE	MODE
te/line	emulate
8. Press **[SHIFT]**, **[6]** to setup the AM8a for MF dialing.
9. Press the **MENU** keys until the display shows:

LOOP TYPE	START SIGNAL
pulse	wink
10. Press the **FIELD** and **VALUE** keys until the display shows:

LOOP TYPE	START SIGNAL
mf	wink
11. If it is desirable to change any other values, such as changing from E&M to loop start, repeat the same process as shown in steps 5 - 10. The AM8a will always power up in the same configuration, so it is only necessary to change those values that are different from its default state.
12. The AM8a is now ready to originate a call. Press **[SHIFT]**, **[1]** so that the AM8a will display the call.
13. Press **[SHIFT]**, **[KP]** to toggle the **INPUT LED** on. This connects the AM8a to the circuit under test.

14. Press **[SHIFT]**, **[AUTO]** to toggle the **AUTODIAL LED** on. The AM8a will now dial upon the detection of the proper start signal, in this case, a wink. Make sure the autodial number you programmed earlier is still displayed in the **SETUP: AUTODIAL** section if the AM8a does not output.
15. Press the **SEIZE** key to initiate an **Off Hook**.
16. By turning up the volume knob, the user should hear the call take place.
17. The user can now conference on another party by manually dialing the following digits from the front keypad:
 - a. Press ***** for approximately 3 seconds
 - b. Press **12** and wait for a progress tone
 - c. Press **0** + the **desired telephone number** of the party you wish to conference
 - d. After answer, press ***** for approximately 3 seconds
 - e. Press **13** to bridge all three parties together
 - f. Press **SEIZE** to hang up

APPLICATION NOTE #2

DS1/T1 Drop and Insert

This application note describes the method of “dropping” a DS0 signal out of a DS1 stream and “inserting” a new DS0 signal into the same timeslot in the DS1 stream. This is all performed without interrupting service on the remaining 23 timeslots. Drop and Insert can be performed in either direction (east/west, line/equip.), but only in one direction at a time. The direction not selected will be idled.

SETUP PROCEDURES

1. Power up the AM8a and wait 3 seconds for self test to complete.
2. Press [SHIFT], [5] to enter the **SETUP: CONFIGURATION** menu.
3. Press the **MENU** keys until the display shows:

INPUT
pcm 1 on

4. Press the **FIELD** and **VALUE** keys until the display shows:

INPUT
rpt1 to 2
or
INPUT
rpt2 to 1

5. Press [SHIFT], [KP] to toggle the **INPUT LED** on. This connects the AM8a to the PCM1 and PCM2 jacks.
6. Press [SHIFT], [2] to enable the meter display.
7. Press the **MENU** up/down keys until the display shows the bit states of all 24 channels.

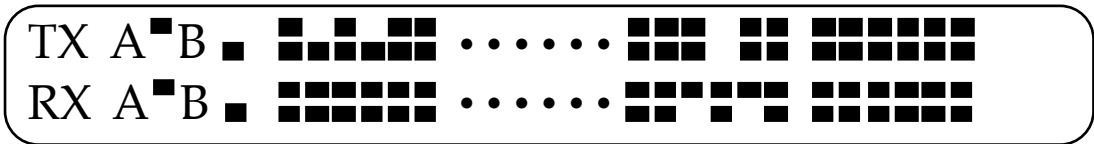

8. Connect the AM8a PCM jacks to the DSX as follows:
 - a. Connect the **RX** for **PCM1** to the monitor jack of the direction that should source timing,

IMPORTANT NOTE: The AM8a is expecting a “padded” signal into the **PCM1** and **PCM2 X** jacks consistent with that of a signal from a resistor isolated monitor jack. If the monitor jacks are not resistor-isolated, use the Ameritec resistor cables provided with the AM8a (P/N 48-0131).

- b. Locate the monitor jack for the other direction (**LED** above **DSX MON JACK** will be blinking) and connect the **RX** for **PCM2** to it.
- c. At this point, ABCD signaling bit LEDs on AM8a front panel should stop scrolling indicating frame synchronization has been established. If these LEDs are still scrolling, the user should check to see that either the correct framing format has been chosen, the cables used are good or that the timing source is connected to the **PCM1 RX** input jack.
- d. Next, connect the **PCM1 TX** jack to the **DSX IN** (lower) jack associated with the monitor jack that is connected to **PCM1 RX**.
- e. Finally connect **PCM2 TX** jack to the **DSX IN** (lower) jack associated with the monitor jack that is connected to **PCM2 RX**.

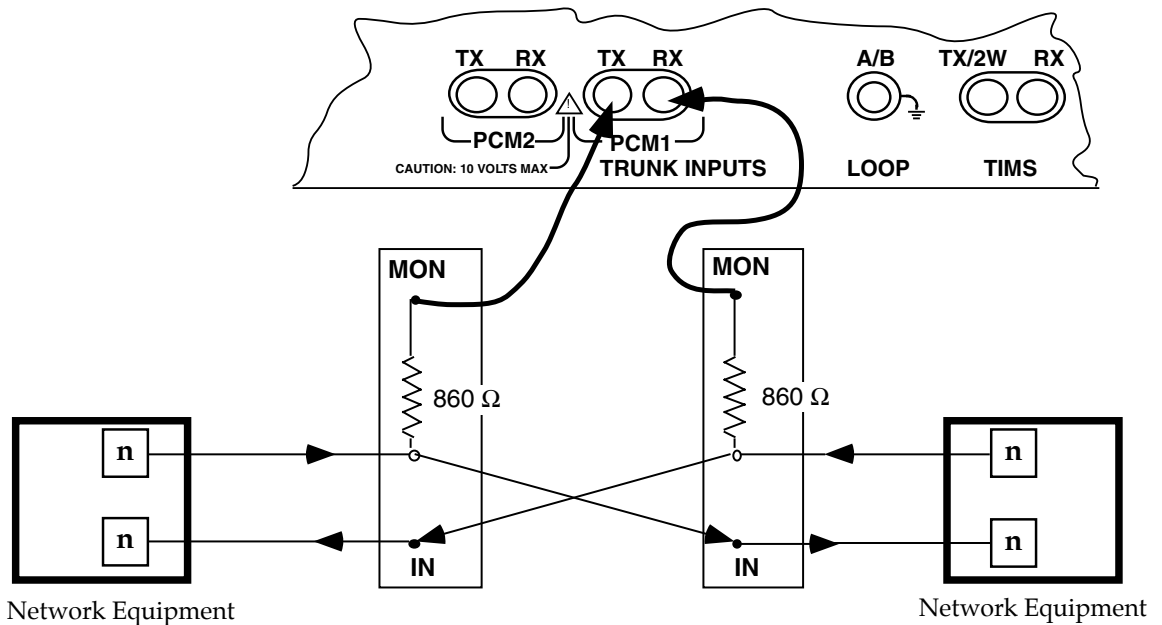

9. Using the A/B bit display, identify either an idle timeslot or the timeslot you are interested in dropping out.
10. To select a channel other than channel 1 to drop and insert, Press [SHIFT], [5].
11. Press the **MENU** keys until the display shows:

CHAN
1
12. Press the **FIELD** keys until the "1" is blinking and then enter the correct channel number to drop and insert. Verify through the speaker that the channel is still idle.
13. Press the **MENU** keys until the display shows:

MODE
monitor

14. Press the **FIELD** and **VALUE** keys until the display shows:

MODE
emulate

The AM8a is now working in a drop and insert mode of operation for an E&M circuit. For other types of circuits, it would be necessary to select those values in the **SETUP: CONFIGURATION** menu.

CONFIGURE DIALED DIGITS AND DIAL TYPE

1. Press **[SHIFT], [8]** to enter autodial section.
2. With the blinking cursor to the far left of the display, select the appropriate autodial field (0 - 9) by pressing the **MENU** up/down keys until the desired field is displayed.
3. With the field selected, enter in the dialed number. (If dialing in MFR1, remember to include the KP and ST digits in this sequence).
4. To change the dial type from pulse to MFR1, press **[SHIFT], [6]**.
5. Press the **MENU** keys until the display shows:

LOOP TYPE	START SIGNAL
pulse	wink
6. Press the **FIELD** and **VALUE** keys until the appropriate dial type and start signal has been selected.
7. Press **[SHIFT], [AUTO]** to enable the autodial capabilities of the AM8a.

DROP AND INSERT TEST

1. The AM8a is now ready to originate a call. Press [**SHIFT**], [**1**] so that the AM8a will display the call.
2. To originate a call, Press the **SEIZE** key. The AM8a will automatically outpulse the digit sequence selected in the **SETUP: AUTODIAL** menu. If manual dialing is desirable, simply toggle off the **AUTO LED** and key in the desired digits after the appropriate start signal is returned to the AM8a.
3. Upon answer by the far end, the user may talk by enabling the speakerphone by pressing the [**SHIFT**], [**TALK**] keys. Alternatively, a tone could be sent by pressing [**SHIFT**], [**RING**]. The AM8a will default to 1004 Hz tone at -10 dBm.
4. To disconnect the call, simply press the **SEIZE** key again.
5. To switch directions and emulate the C.O. side, press [**SHIFT**], [**5**].
6. Press the **MENU** keys until the display shows:
INPUT
rpt1 to 2
7. If you were using "rpt1 to 2" press the **VALUE** up key to select "rpt2 to 1" or alternatively, if you were using "rpt2 to 1" press the **VALUE** down key to select "rpt1 to 2".
8. Toggle the **AUTO LED** on for the AM8a to automatically provide the appropriate start signal upon detection of seizure.

APPLICATION NOTE #3

Direct Inward Dial (DID)/911

This application note will explain the procedure for emulating the customer terminal with the AM8a. This allows for DID/911 turn-ups to occur without the need for customer equipment to be in the picture. The user can now know if the circuit will work before the customer is hooked up and the service is delivered, eliminating turn up problems and allowing for quick and error free service to be delivered.

SETUP PROCEDURES

1. Power up the AM8a and wait 3 seconds for self test to complete.
2. Press [SHIFT], [5] to enter the **SETUP: CONFIGURATION** menu.

3. Press the **MENU** keys until the display shows:

IMITATE	MODE
switch	monitor

4. Press the **FIELD** and **VALUE** keys until the display shows:

IMITATE	MODE
te/line	emulate

5. Press the **MENU** keys until the display shows:

ANALOG IMPEDANCE	ANALOG/PCM
900 ohms	pcm loop clk

6. Press the **FIELD** and **VALUE** keys until the display shows:

ANALOG IMPEDANCE	ANALOG/PCM
900 ohms	analog

7. Press the **MENU** keys until the display shows:
TRUNK TYPE
e&m 4w
8. Press the **FIELD** and **VALUE** keys until the display shows:
TRUNK TYPE
did
9. Press **[SHIFT]**, **[6]** to enter the **SETUP: EMULATE** menu.
10. Press the **MENU** keys until the display shows:
LENGTH ohm
1200
11. If 1200 ohms loop length is not desirable, use **value** keys to adjust from 0 to 2100 ohms.
12. Press the **MENU** keys until the display shows:
LOOP TYPE
pulse
13. If pulse dialing is not desirable, press the value keys until DTMF is selected.

OPERATION

1. Press **[SHIFT]**, **[1]** so that the AM8a will display the call.
2. Press **[SHIFT]**, **[KP]** to toggle the **INPUT LED** on. This connects the AM8a to the circuit under test.
3. Press **[SHIFT]**, **[AUTO]** to automatically enable the start signal upon seizure.

4. Upon detection of seizure from C.O. end, the AM8a will provide a wink and then capture the outpulsed digit sequence.
5. By pressing the **FIELD** keys, place the cursor under the ">" at the far left of the digit string. If there are any errored parameters in the display, the bottom line will flash. If flashing, the user can then scroll across each event in the display until a flashing parameter is noticed, indicating the event that is errored. If the bottom display line doesn't flash, the call occurred with no errors.

APPLICATION NOTE #4

SLC®96 Monitoring and Data Link Analysis

With loop carrier problems, it is necessary to quickly determine if the cause of trouble lies within the remote terminal, the digital span line or the central office terminal. The AM8a PCM/VF Call Analyzer allows both central office and field technicians to quickly isolate problems on SLC®96, Integrated SLC® and DISC*S systems by monitoring T1 span line errors, SLC® Datalink and Alarm information, signaling activity and channel level impairments.

SETUP PROCEDURES

1. Power up the AM8a and wait 3 seconds for self test to complete.
2. Press **[SHIFT], [5]** to enter the **SETUP: CONFIGURATION** menu.
3. Press the **MENU** keys until the display shows:
FRAMING
D3/D4
4. Press the **FIELD** and **VALUE** keys until the display shows:
FRAMING
SLC®96 I

If Mode II is desired, press the value key until “**SLC®96 II**” is displayed.

5. Press the **MENU** keys until the display shows:

SLC® TYPE

single party

Single party is selected for loop start trunks for Mode I and Mode II. If ground start is desirable, press the value keys until “**universal vg**” is selected.

6. Connect the AM8a’s **PCM1 RX** jack to the **DSX** monitor jack coming from the central office equipment. (PCM1 RX must always be connected to the timing source).
7. Connect the AM8a’s **PCM1 TX** jack to the **DSX** monitor jack coming from the remote terminal equipment.
8. Press [**SHIFT**], [**KP**] to toggle the **INPUT LED** on. This connects the AM8a to the circuit under test.

VIEW SPAN RESULTS AND ALARM CONDITIONS

1. To view any span errors or SLC®96 alarms, press [**SHIFT**], [**2**] to enter the meter display.
2. Press the **MENU** and **VALUE** keys to display such events as T1 levels, A/B bit states, slips, alarms, protection fields, etc.
3. Note that the A/B bit status display provides the current status of any of the 24 timeslots, grouped in increments of 6 timeslots. These timeslots should not be confused with channels since channels designations are different than timeslot designations.

SLC-96 ALARMS (SELECT VIA DISPLAY METER)

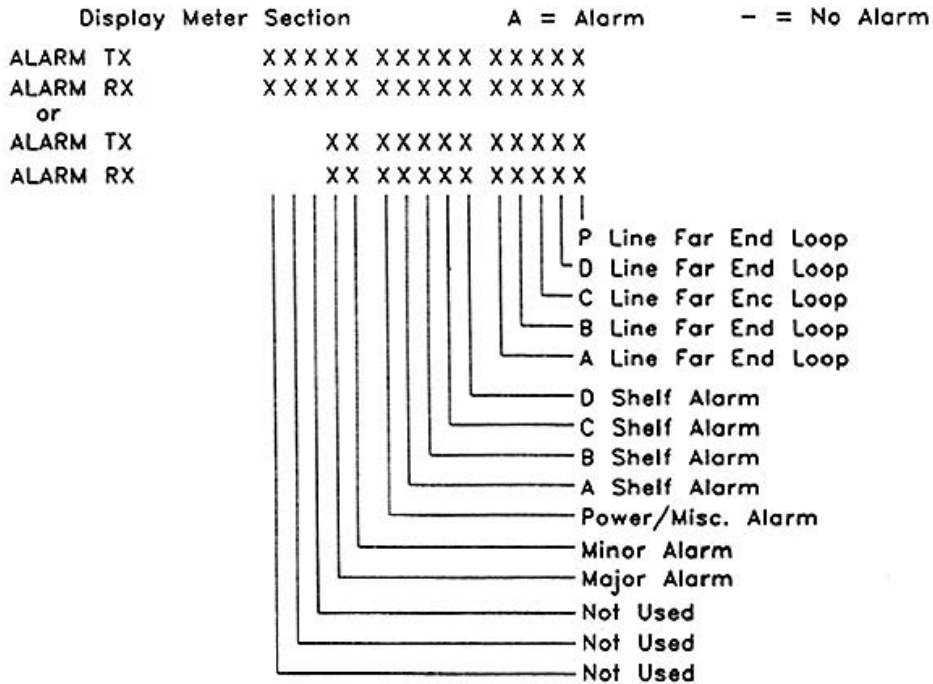

SLC-96 PROTECTION STATUS (SELECT VIA DISPLAY METER)

		XXXX	MESSAGE
		1111	IDLE
PROTECTION TX	XXXX	1110	SWITCH LINE A RECEIVE
		1101	SWITCH LINE B TRANSMIT
PROTECTION RX	XXXX	1100	SWITCH LINE C TRANSMIT
		1010	SWITCH LINE D TRANSMIT
		0101	SWITCH LINE B TRANSMIT & RECEIVE
		0100	SWITCH LINE C TRANSMIT & RECEIVE
		0010	SWITCH LINE D TRANSMIT & RECEIVE

SLC-96 MAINTENANCE MESSAGES (SELECT VIA DISPLAY METER)

MAINTENANCE TX M1 M2 M3 MX=1= Message Present
 MAINTENANCE RX M1 M2 M3 MX=0= No Message Present

	Message From LDS to RT	Message From RT to LDS
M1	ON HOOK	SEIZE
M2	PROCEED CR	PROCEED RC
M3	TEST ALARM CR	TEST ALARM RC

VIEW SIGNALING EVENTS (DIGITS, TONES, SEIZURES)

1. To view the signaling events decoded on a given timeslot, press **[SHIFT], [1]** so that the AM8a will display all digits, off hooks, etc. that are detected.
2. If it is desirable to capture calls on a timeslot other than channel 1 (**default**), press **[SHIFT], [5]** to enter **SETUP: CONFIGURATION**.
3. Press the **MENU** keys until the display shows:

CHAN
1
4. To select any given timeslot, enter a value of **1** to **24**.
To select any given channel, enter a value of **-1** to **-96**.
To select a random mode of operation, enter a value of **0**. This allows the AM8a to automatically scan for the next call upon the completion of the call currently analyzed.
5. Upon selection of the desired channel, press **[SHIFT], [1]** to display the call events.

MODE II OPERATION

The AM8a can also be configured to monitor MODE II (Concentrated) types of calls. This type of operation involves having 48 subscribers (channels) vying for 24 available timeslots. In addition to performing its usual analysis, the AM8a can also perform channel to timeslot mapping and a detailed analysis of the 4 kb datalink messaging.

DATALINK MONITORING

1. To monitor the 4 kb datalink, it is first necessary to make the appropriate channel selection in the AM8a.

2. Press **[SHIFT]**, **[5]** to enter the **SETUP: CONFIGURATION** menu.
3. Press the **MENU** keys until the display shows:
CHAN
1
4. Enter a channel selection of **-97** to select the 4 kb datalink.
5. Press the **MENU** keys until the display shows:
FRAMING
SLC®96 I
6. Press the **FIELD** and **VALUE** keys until the display shows:
FRAMING
SLC®96 II
7. Press the **MENU** keys until the display shows:
SLC® MSG
000000001
8. Using the **FIELD** and **VALUE** keys, selectively toggle on those Concentrator Field Messages that the user desires the AM8a to decode by changing the "0" values to a "1" value. It is suggested that the user disable the "idle" messages as they will quickly overrun the AM8a's display buffer and thus prevent the user from capturing those messages of special interest.

CONCENTRATOR FIELD MESSAGES (SLC MSG) (SELECT VIA CONFIG MENU)

Used in Mode II operation, this field allows user to select which Concentrator Field Messages are displayed.

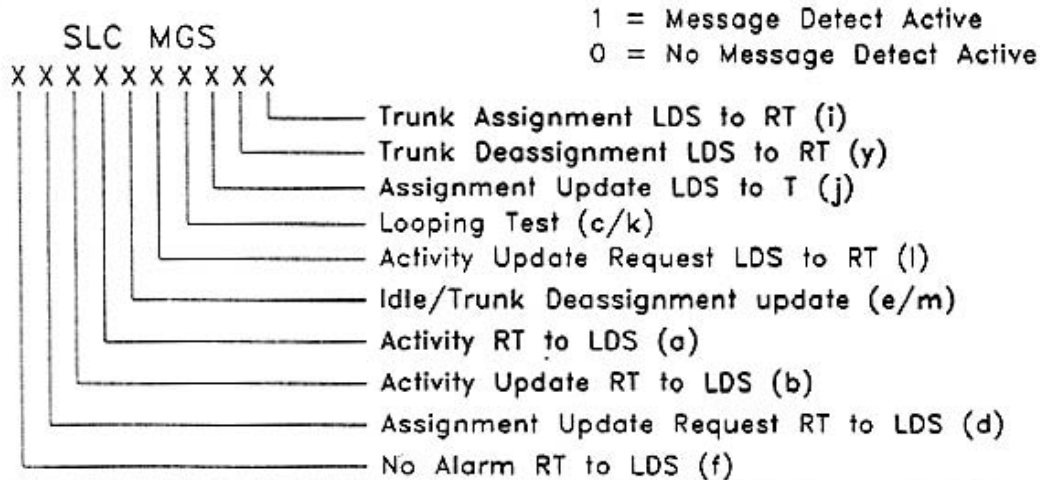

9. Once these steps are completed, press [SHIFT],[1] to display the datalink messages.

APPLICATION NOTE #5

DS1/T1 Signal Monitoring

This application note describes the capabilities of the Ameritec Model AM8a PCM/VF Call Analyzer to perform T1 signal monitor testing. The AM8a provides a variety of non-intrusive PCM digital tests including transmission errors, frame synchronization, signaling bit status and channel noise measurements. The unit is also equipped with a digital dual multimeter for measuring level, frequency and amplitude on selected channels and the span itself.

Upon power-up, the AM8a will default to monitoring a T1 with E&M signaling. The framing is set to D3/D4 and channel 1 has already been selected for monitoring. This application note will help step the user through any changes necessary for configuring the AM8a for circuits other than the AM8a's default state.

SETUP PROCEDURES

1. Power up the AM8a and wait 3 seconds for self test to complete.
2. Because the AM8a powers up in a T1 monitoring configuration, place the unit on-line by pressing [SHIFT], [KP] to toggle the INPUT LED on. This connects the AM8a to the circuit under test.

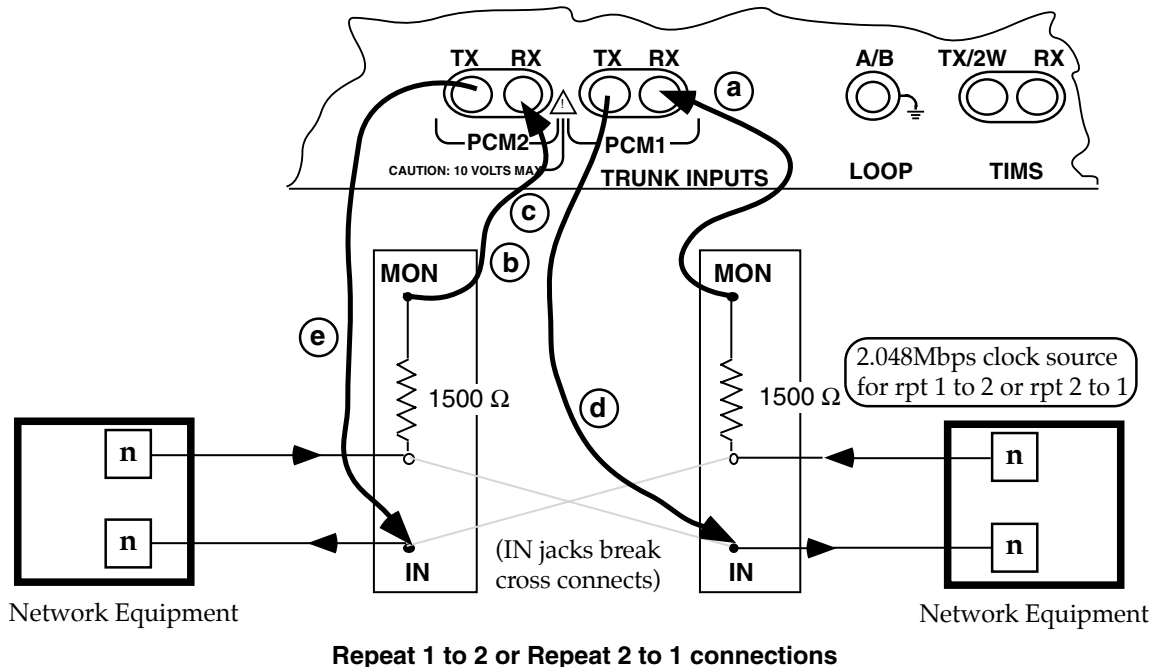

3. Connect the AM8a PCM jacks to the DSX as follows:
 - a. Connect the **RX** for **PCM1** to the monitor jack of the direction that should source timing,

- b. Locate the monitor jack for the other direction (**LED** above **DSX MON JACK** will be blinking) and connect the **TX** for **PCM1** to it.
- c. At this point, ABCD signaling bit LEDs on the AM8a front panel should stop scrolling indicating frame synchronization has been established. If these LEDs are still scrolling, the user should check to see that either the correct framing format has been chosen, the cables used are good or that the timing source is connected to the **PCM1 RX** input jack.

IMPORTANT NOTE: The AM8a is expecting a “padded” signal into the PCM1 jacks consistent with that of a signal from a resistor isolated monitor jack. If the monitor jacks are not resistor-isolated, use the Ameritec resistor cables provided with the AM8a (P/N 48-0131).

PARAMETER CHANGES

1. If it is desirable to change any of the parameters from their default state, press [**SHIFT**], [**5**] to enter the **SETUP: CONFIGURATION** menu. All parameters that control the T1 circuit types, framing, etc. are located in this menu.
2. When in this menu, press the **MENU** keys to display the field to be changed.
3. When the desired field is displayed, press the **FIELD** and **VALUE** keys to select the appropriate field and change the parameter to the desired value.

METER DISPLAY (A/B BIT STATES, SPAN ERRORS, ETC.)

All T1 span measurements such as slips, frame errors, level, etc. are displayed in the Meter Section. To access these results:

1. Press [**SHIFT**], [**2**] to enter the Meter Display.
2. Press the **MENU** keys to display the various span measurements described above.
3. If it is desirable to reset any of the measurements shown on the display, the user needs to press [**SHIFT**], [**D**] while that measurement is displayed.
4. There are two screens in the Meter Display that may require the user to use the **FIELD** and **VALUE** keys to select a desired measurement. These screens are shown below:

MEASURE	SCALE	MEASURE	SCALE
Vt-r	100	Vr-g	5
and,			
	NOISE	65dBm	
INPUT TX		FILTER	CMMSG

To select values other than those shown, use the **FIELD** and **VALUE** keys to scroll through the parameter selections.

A/B SIGNALING BIT STATUS

While in the Meter Display, it is possible to view the bit states of all 24 timeslots simultaneously. The timeslots are arranged in four groups of six and each timeslot's A/B bit can be monitored by viewing the rectangular LCD bars that correspond to the TX and RX A/B bits. If an A/B bit is in an active (high) state, the LCD bar that corresponds to that signaling bit will appear. If no LCD bar is present, then that timeslot's signaling bit is in an inactive (low) state. A dot will appear if neither signaling bit is active.

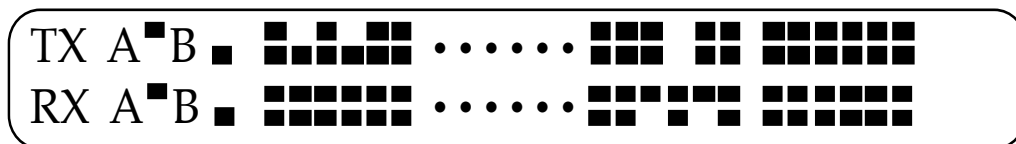

If the AM8a is not in a valid mode for this display, dots will appear in **all** bit positions.

APPLICATION NOTE #6

Originating or Terminating a DS/T1 Call

The following example illustrates how the AM8a can be configured to originate or terminate a call on one channel of a T1.

SETUP PROCEDURES

1. Power up the AM8a and wait 3 seconds for self test to complete.
2. Press [SHIFT], [5] to enter the **SETUP: CONFIGURATION** section.
3. Press the **MENU** keys until the display shows:

IMITATE	MODE
switch	monitor

4. Press the **FIELD** and **VALUE** keys until the display shows:

IMITATE	MODE
te/line	emulate

If it is desirable to terminate the call as a switch, then change the **IMITATE** field to "switch".

To originate a call, the AM8a will only dial if the **IMITATE** field is set to **"te/line"**. The only exception to this operation is for **E&M** circuits which can dial regardless of setting since **E&M** circuits are symmetrical in design.

5. Press the **MENU** keys until the display shows:

ANALOG IMPEDANCE	ANALOG/PCM
900 ohms	pcm loop clk

If it is desirable to have the AM8a source timing on the T1 circuit, change the **ANALOG/PCM** setting to "pcm int clk".

6. Press the **MENU** keys until the display shows:

INPUT	FRAMING	ZERO SUP	CHAN
pcm 1 on	D3/D4	AMI	1

Make any changes to the framing and zero suppression formats by selecting each entry and pressing the **VALUE** keys until the desired value is displayed. Channel selection changes can be made by directly entering the numeric value into this field.

7. Press the **MENU** keys until the display shows:

TRUNK TYPE	E&M TYPE
E&M 4W	1

Change the **TRUNK TYPE** to match the signaling of the T1 you are working with (E&M 4W, DID, Loop Start, Ground Start). For FX signaling, select "loop" or "ground" and use the **IMITATE** selection in Step 4 to change from FXO ("switch") to FXS ("te/line").

If signaling formats other than these are used, press the **MENU** down [C] key, until the display shows:

PCM	Off HK a/b	On HK a/b
Config2 auto	auto	

Use the Field and Value keys to select the desired on hook and off hook states. These states include auto, 0/0, 0/1, 1/1, 0/X, 1/X, X/0 and X/1, where X denotes a don't care state.

Any selections made here will override previous selections made in the trunk configuration display. To return to any of the standard selections in the trunk configuration display, reset both the "off hook" and "on hook" fields in the PCM Config2 display to "auto".

8. Press the **MENU** keys until the display shows:

LOOP TYPE	START SIGNAL
pulse	wink

Use the **FIELD** and **VALUE** keys to change the **LOOP TYPE** to the type of dialing you will use: DTMF, Dial Pulse or MF(R1). Use the same procedure to select the proper start signal for the circuit: Wink, Immediate, Delay or Dial tone. Note: MF(R1) is normally used on E&M trunks and pulse/DTMF are normally used on loop and ground trunks.

9. Dialing digits on a channel can be accomplished on the AM8a either by using the **AUTO DIAL** mode or by dialing manually from the keypad.

To enter the **AUTO DIAL** field, simply press [**SHIFT**], [**8**]. Up to 10 dialing sequences can be stored. Press the **MENU** up/down keys to scroll to an unused dialing field or write over an existing field. Enter digits into the field from the keypad. The dialing sequence shown on the display will be the one used for the **AUTO DIAL**.

OPERATION

1. Press [**SHIFT**], [**1**] so that the AM8a will display the call.
2. Press [**SHIFT**], [**KP**] to toggle the **INPUT LED ON**. This connects the AM8a to the circuit under test.

3. Now connect the AM8a to the T1 transmit and receive jacks. When frame sync is established the ABCD LEDs will stop scrolling and the LEDs will indicate channel conditions. Also the status LEDs will show the trunk selection, whether the unit is emulating switch or terminal/line and if the **PCM1** or **PCM2** jacks on the AM8a has been selected.
4. Press **[SHIFT]**, **[AUTO]** to automatically enable the auto dial feature if desirable. Otherwise, manually dial each digit by pressing the appropriate numbers on the front panel.

TERMINATING AN INBOUND CALL

1. To terminate an inbound call:

A capital **"H"** on the display indicates a seizure for E&M or DID signaling whereas a capital **"R"** on the display indicates a seizure (ringing) for FX signaling. Press the **SEIZE** key to answer the call.

ORIGINATING A CALL

1. To originate a call, press the **SEIZE** key to generate an OFF Hook (shown as a capital **"H"**)
2. If the AM8a is in the **AUTO DIAL** mode, the AM8a will automatically outpulse the digits upon receiving the programmed start dial.
3. If not in the **AUTO DIAL** mode, when the start signal is received (dial tone for **FX** and typically a wink for E&M/DID), digits can be outpulsed manually by pressing the keys directly.
4. To go back On Hook, press the **SEIZE** key again (small **"h"** is displayed).

APPLICATION NOTE #7

Digit Analysis and Exception Reporting

The following example illustrates how the AM8a monitors dialed digits and reports exceptions based on preset thresholds. Exceptions can be shown via both the display and printout. This application note assumes the user has already configured the AM8a for proper trunk type, start signal, etc.

SETUP PROCEDURES

1. Press [SHIFT], [5] to enter the **SETUP: CONFIGURATION** section.
2. Press the **MENU** keys until the display shows:

MODE	DIG DET
new call reset	narrow
3. The **DIGIT DETECT** field defines the way in which the AM8a will display or print dialed digit events. The default state of "narrow" will result in the AM8a displaying/printing those dialed digits that are exceptions to the expected values or are within expected values. The "wide" selection results in all dialed digits including those that are unrecognizable being displayed/printed. The "limit" selection results in only those dialed digits that meet the pre-set thresholds being displayed or printed.
4. Press the **MENU** keys until the display shows:

AUTOPRINT
off
5. Press the **VALUE** keys until the appropriate selection is made (flawed calls, events only or flawed calls, events & details) that determines whether the AM8a prints out the corresponding analysis information for each digit detected.

6. Press the **MENU** keys until the display shows:

BAUD RATE	PARITY	CR DELAY
9600	none	0

Press the **FIELD** and **VALUE** keys to select the appropriate values that match your printer settings.

CONFIGURING ANALYZE THRESHOLDS

1. Press [**SHIFT**], [**7**] to enter **ANALYZE** menu.
2. Press the **MENU** keys until the display shows:

SPEEDpps(min/max)	BREAK%
8.0 12.0	50 70

Use the **FIELD** and **VALUE** keys to select each parameter and make any changes to the default values. The ranges shown indicate that a dial pulse digit detected within these values will be a "good" digit with respect to speed and break.

3. Press the **MENU** keys until the display shows:

INTRDIGIT ms(min)
300

Use the **VALUE** keys to change the interdigit timing in one (1) millisecond increments. The value selected will represent the minimum value of interdigit timing that is acceptable for a "good" digit.

4. Press the **MENU** keys until the display shows:

LO BAND dB(min/max)	HI BAND dB
-15 -3	-15 -3

Use the **FIELD** and **VALUE** keys to select each parameter and make any changes to the default values. These values apply both to **DTMF** and **MF (R1)** levels for both the low and high band signals and represent the value that a digit must fall within to be considered "good".

5. Press the **MENU** keys until the display shows:

FREQ % (max)	TWIST dB (min/max)
1.5	-6 6

Use the **FIELD** and **VALUE** keys to select each parameter and make any changes to the default values. These values apply both to **DTMF** and **MF (R1)** digits. The **FREQ** field represents the maximum amount of frequency deviation allowed for a "good" digit's low band or high band frequency component. The **TWIST** field represents the difference between the low band level and high band level of a digit.

6. Press the **MENU** keys until the display shows:

TONE ON/OFF ms(min)	GUARD ms
35 35	20

Use the **FIELD** and **VALUE** keys to select each parameter and make any changes to the default values.

The **TONE** field represents the minimum on-time and off-time that each digit must be present and quiet, respectively to be a "good" digit.

The **GUARD** field is important because it is used to determine the minimum on-time that a digit must be present before the AM8a will analyze it. Any event shorter than the **GUARD** time will be ignored by the AM8a regardless of how any other parameter is programmed.

OPERATION

1. Press **[SHIFT], [1]** so that the AM8a will display the call.
2. Press **[SHIFT], [KP]** to toggle the **INPUT LED** on. This connects the AM8a to the circuit under test.
3. Now connect the AM8a to the circuit under test.

DISPLAYING EXCEPTIONS

1. To display exceptions on hard-copy printout, connect the AM8a's RS232 port to a serial ASCII printer. As errored calls are detected, the information will print out automatically to the printer based on those settings configured in this application note.
2. To determine whether a call has an errored digit when no printer is available, the user can view the display to determine the errored event.

To accomplish this, the user should place the display marker (underline) under the "greater than sign". If an errored event has occurred, the bottom display line will blink.

The user can then move the display marker from event to event until the user encounters a blinking value on the bottom line. That blinking value indicates the parameter that has fallen out of the range of the pre-set analyze thresholds.



Ameritec is dedicated to serving the worldwide telecommunications community by providing competitively priced, state-of-the-art test equipment that is supported by the finest in marketing, engineering development and customer service.

Ameritec

760 Arrow Grand Circle
Covina, CA 91722 USA

TEL 626.915.5441

FAX 626.915.7181

www.ameritec.com